

Kofax Import Connector

2.3.0

Developer's Guide



© 2009 - 2013 Kofax, 15211 Laguna Canyon Road, Irvine, California 92618, U.S.A. All rights reserved. Use is subject to license terms.

Portions © 2009 - 2013 Kofax Austria GmbH. All rights reserved.

Third-party software is copyrighted and licensed from Kofax's suppliers.

THIS SOFTWARE CONTAINS CONFIDENTIAL INFORMATION AND TRADE SECRETS OF KOFAX. USE, DISCLOSURE OR REPRODUCTION IS PROHIBITED WITHOUT THE PRIOR EXPRESS WRITTEN PERMISSION OF KOFAX.

Kofax, the Kofax logo, and the Kofax product names stated herein are trademarks or registered trademarks of Kofax in the U.S. and other countries. All other trademarks are the trademarks or registered trademarks of their respective owners.

U.S. Government Rights Commercial software. Government users are subject to the Kofax standard license agreement and applicable provisions of the FAR and its supplements.

You agree that you do not intend to and will not, directly or indirectly, export or transmit the Software or related documentation and technical data to any country to which such export or transmission is restricted by any applicable U.S. regulation or statute, without the prior written consent, if required, of the Bureau of Export Administration of the U.S. Department of Commerce, or such other governmental entity as may have jurisdiction over such export or transmission. You represent and warrant that you are not located in, under the control of, or a national or resident of any such country.

DOCUMENTATION IS PROVIDED "AS IS" AND ALL EXPRESS OR IMPLIED CONDITIONS, REPRESENTATIONS AND WARRANTIES, INCLUDING ANY IMPLIED WARRANTY OF MERCHANTABILITY, FITNESS FOR A PARTICULAR PURPOSE OR NON-INFRINGEMENT, ARE DISCLAIMED, EXCEPT TO THE EXTENT THAT SUCH DISCLAIMERS ARE HELD TO BE LEGALLY INVALID.

Contents

Legal Notice	2
Overview	5
Introduction	5
Related Documentation	5
Help	5
Release Notes	5
Message Connector Web Services Interface	7
Conformance to Standards	7
GetNewImportID Function	7
Import Function	8
TrackImport Function	10
GetContentTypeList and GetContentTypeDescription Functions	11
Example: Input of Unstructured Message	13
Example: Input of Customer-Specific XML Document	13
Example: Compatibility with KCIC Web Services	13
XML Mapping	15
Using Sample Files	18
Importing Structured Data via Simple XML Mapping	18
Importing Structured Data via XML Import Connector-Compatible Mapping	20
Importing Structured Data via Generic Mapping	22
Creating XSL Transformations Manually	25
Web Services Sample Client	29
Web Services Interface for Kofax Monitor	31
KC Plug-In	31
GetAllStates Function	31
GetConnection Function	32
GetConnectionNames Function	33
GetFeatureLicenseState Function	33
Message Connector	33
GetRunState Function	34
GetStorageVisible Function	34
GetMessagesFailed Function	34
GetMessagesWaiting Function	35
Scripting Interface	37
Adding References to Scripts	37
IBatchNameFormatter Interface Definition	38

IDocumentScript2 Interface Definition	39
Custom Conversion Script	43
Configuring Custom Conversion Script	43
Sample Script	43
Custom Storage Strings	45

Overview

Introduction

This guide contains additional information about the interfaces of Kofax Import Connector, including:

- Description of the functions of the [Message Connector Web Services Interface](#)
- Information about the [Web Services Sample Client](#)
- Description of the [Scripting Interface](#)
- [Custom Storage Strings](#)

This guide assumes that you have a thorough understanding of Windows standards, applications, and interfaces. It also assumes that you have a thorough understanding of web services and Kofax Capture.

This guide is for developers who are intend to create a custom web service application or scripts for customizing Kofax Import Connector.

Related Documentation

In addition to this Kofax Import Connector Developer's Guide, the following additional documentation is available:

- Kofax Import Connector Installation Guide
- Kofax Import Connector Administrator's Guide
- Message Connector Help
- KC Plug-In Help
- Release notes

Help

The online Help systems included in Kofax Import Connector provide online assistance for system administrators and operators alike. You can access online Help from any application window by clicking Help.

Release Notes

Late-breaking product information is available from release notes. You should read the release notes carefully, as they contain information that may not be included in other Kofax Import Connector documentation.

Message Connector Web Services Interface

Message Connector can act as an HTTP/HTTPS server that accepts standard web-service calls from any customer application. The interface is described by a WSDL file that can be imported by commonly used development tools (e.g. Microsoft VisualStudio):

```
http://{message-connector}:{port}/file/import.wsdl
```

The web service interface provides functions for importing documents to Kofax Capture. All other functions used by the internal web-service interface (for example, access to Web UI, get/view messages, etc.) are not supported by this HTTP server. You can safely use it in low-trusted networks or even the Internet.

Message Connector also provides several functions for use with Kofax Monitor. These functions are described in chapter [Web Services Interface for Kofax Monitor](#).

Conformance to Standards

The web service interface is based on the Simple Object Access Protocol (SOAP) 1.1, W3C Note 08 May 2000 (<http://www.w3.org/TR/2000/NOTE-SOAP-20000508/>).

The provided Web Service Description Language (WSDL) files use Version 1.1, W3C Note 15 March 2001 (<http://www.w3.org/TR/wsdl>).

All web service calls use the “document-literal” combination of SOAP binding style and data encoding. For a discussion of “document-literal” versus “rpc-encoded” models, see for example:

- <http://java.sun.com/developer/technicalArticles/xml/jaxrpcpatterns/>
- http://msdn.microsoft.com/library/en-us/dnwebsrv/html/rpc_literal.asp
- <http://www-128.ibm.com/developerworks/webservices/library/ws-whichwsdl/>

The HTTP layer implements HTTP/1.1 as defined in RFC 2616. See <http://www.w3.org/Protocols/rfc2616/rfc2616.html>.

The HTTPS implementation is based on the OpenSSL Project, an open source toolkit implementing the Secure Sockets Layer (SSL v2/v3) and Transport Layer Security (TLS v1) protocols. OpenSSL version 0.9.8m from 25 February 2010 is used. See <http://www.openssl.org/>.

GetNewImportID Function

This function is used optionally to get a unique ImportID for a subsequent Import call. The function returns a 128bit GUID. If the client has any other method to generate a GUID it can be used as well.

Import may also be called without specifying an ImportID, but knowing the ImportID in advance allows idempotent input e.g. in case of retries after Import failed without returning a response.

The GetNewImportID function has no parameters and returns a response as shown below:

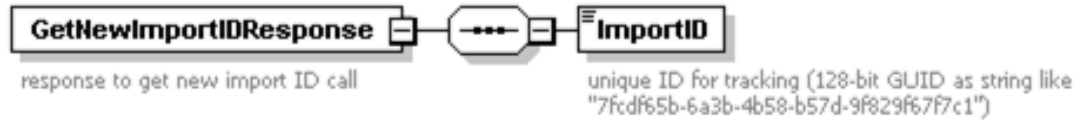

Import Function

This function accepts a list of attachments that are processed like an email. The input schema is shown below:

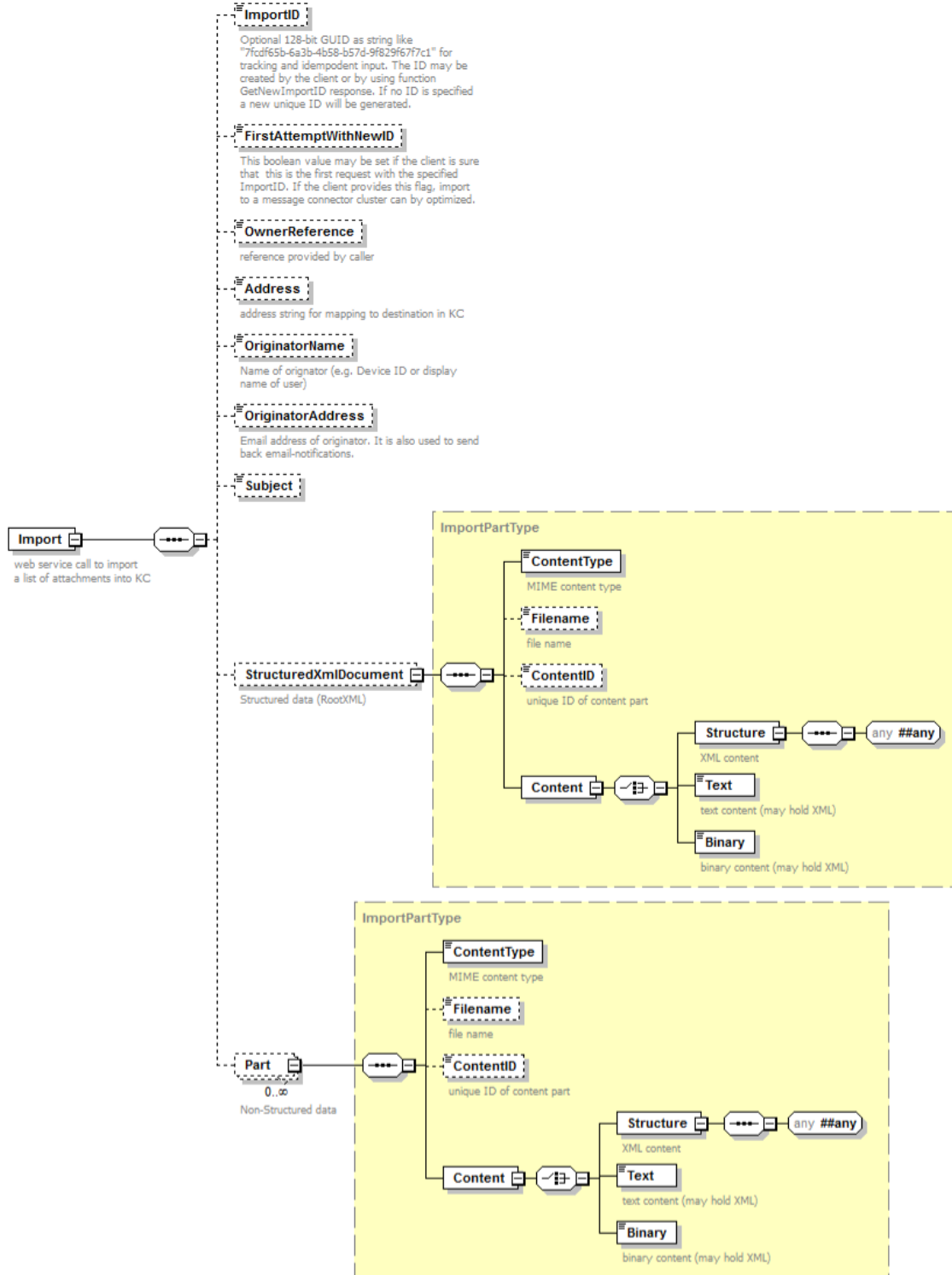

If the input should be handled as an XML message, StructuredXmlDocument must be provided with the content of the root-XML. Both StructuredXmlDocument and all other parts can be provided as (base-64 encoded) binary, (escaped) text, or as XML presentation.

If the message is accepted by the storage the following success response is returned:

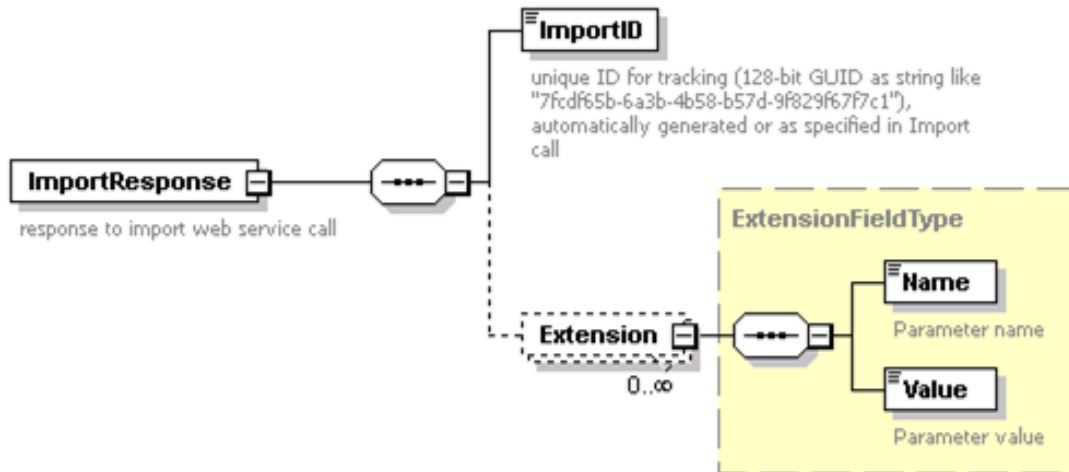

The ImportID returns the internal GUID of the message which may be used for tracking the status with function TrackImport. The Extension values are reserved for future extensions.

If the message is not accepted a standard SOAP fault object is returned.

TrackImport Function

This function returns the status of a message that has been previously imported with function Import.

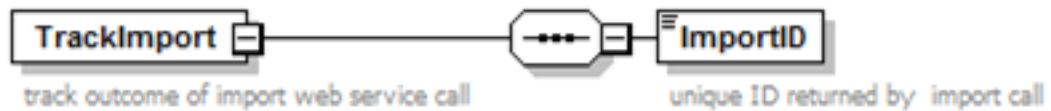

On success, the function returns the status of the message as shown in the response below:

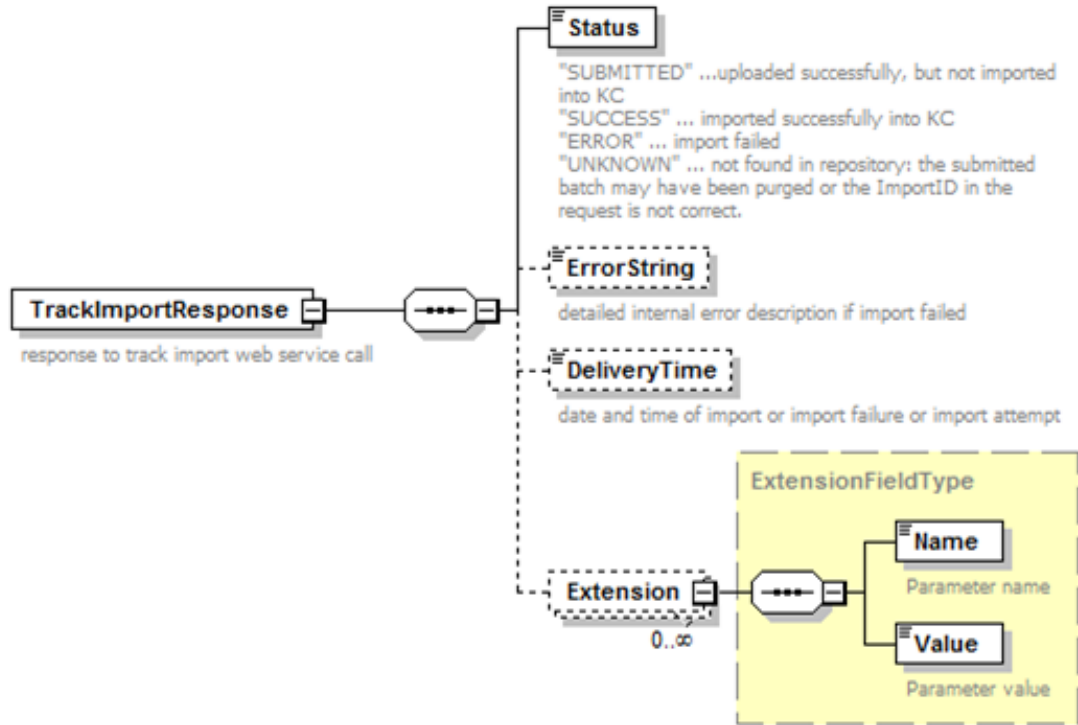

The Status values are defined in the table below:

Status	Description
SUBMITTED	The message has been saved in the Message Connector storage but is not imported into Kofax Capture.
SUCCESS	The message has been successfully imported into Kofax Capture.
ERROR	The message could not be imported into Kofax Capture.
UNKNOWN	The message with the specified ID could not be found in the Message Connector storage. This can be caused by one of the following reasons: <ul style="list-style-type: none"> A bad ImportID was specified in the TrackImport call The message was processed (positive or negative) but it has been removed from the storage because the disk-space was required for new messages.

The ErrorString holds a detailed error description in case that import into Kofax Capture failed. The DeliveryTime is a dateTime field specifying when the import into Kofax Capture took place or failed or will be attempted, depending on the Status value. The Extension values are reserved for future extensions.

GetContentTypeList and GetContentTypeDescription Functions

These functions may be used by clients that need details (e.g. document classes, document fields, etc) about the published batch classes.

Function GetContentTypeList is used to get a list of all available configurations (e.g. batch classes with Kofax Capture). It does not require any input parameters. The response lists the name of each configuration.

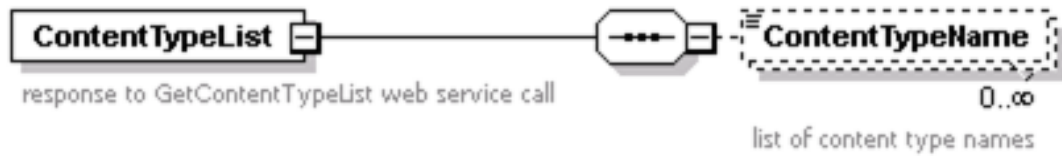

Function GetContentTypeDescription is used to get the content of a specific configuration. It requires the configuration name returned by GetContentTypeList as input and returns the configuration as string. This string contains a KC XML batch definition (located in Kofax Capture folder PubTypes) according to admin.dtd.

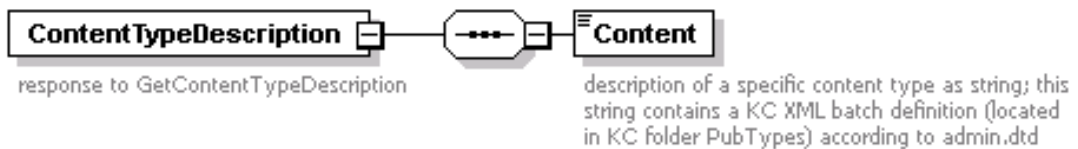
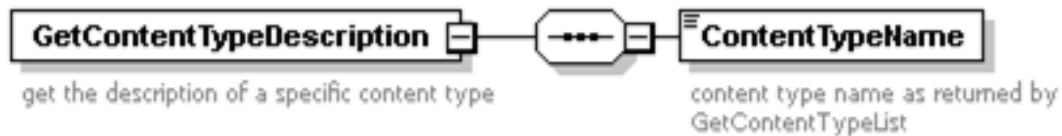

Request	Response
<pre><GetContentTypeList/></pre>	<pre><ContentTypeList> <ContentTypeName>Order Forms </ContentTypeName> <ContentTypeName>batch_class2 </ContentTypeName> </ContentTypeList></pre>
<pre><GetContentTypeDescription> <ContentTypeName>Order Forms </ContentTypeName> </GetContentTypeDescription></pre>	<pre><ContentTypeDescription> <Content> <?xml version="1.0" encoding="UTF-8"?> <!DOCTYPE AscentCaptureSetup SYSTEM "..\Admin.dtd"> <AscentCaptureSetup DatabaseVersion="29" ... > ... </Content> </ContentTypeDescription></pre>

Example: Input of Unstructured Message

This example shows a request which inputs plain text and a TIFF file.

```
<Import>
  <Part>
    <ContentType>text/plain</ContentType>
    <Content>
      <Text>This is a sample text
line 2
line 3
end of text</Text>
    </Content>
  </Part>
  <Part>
    <Filename>page001.tif</Filename>
    <Content>
      <Binary>
        <!-- base64 encoded content of page001.tif -->
      </Binary>
    </Content>
  </Part>
</Import>
```

Example: Input of Customer-Specific XML Document

This example shows a sample request which inputs a customer XML and a Word document.

```
<Import>
  <StructuredXmlDocument>
    <ContentType>text/xml</ContentType>
    <Content>
      <Structure>
        <CustomType>
          <OrderNumber>12345</OrderNumber>
          <CustomerId>3434</CustomerId>
          <Items>
            <Item pcs="1" article="9999"/>
            <Item pcs="5" article="9124"/>
            <Item pcs="3" article="1299"/>
          </Items>
        </CustomType>
      </Structure>
    </Content>
  </StructuredXmlDocument>
  <Part>
    <Filename>document.doc</Filename>
    <Content>
      <Binary>
        <!-- base64 encoded content of document.doc -->
      </Binary>
    </Content>
  </Part>
</Import>
```

The customer XML can be rendered to PDF/TIFF or mapped to Kofax Capture fields.

Example: Compatibility with KCIC Web Services

The web service input of Kofax Import Connector does NOT provide a compatible web service interface, but it supports the use case to create a batch in Kofax Capture according to

an XML document (e.g. according to ACEIDEF.dtd) and additional files (e.g. images). Kofax Import Connector supports this use case with its import function:

```
<Import>
  <StructuredXmlDocument>
    <ContentType>text/xml</ContentType>
    <Content>
      <Structure>
        <ImportSession>
          <Batches>
            <Batch name="batch_name">
              <Pages>
                <Page ImportFileName="page001.tif" />
              </Pages>
            </Batch>
          </Batches>
        </ImportSession>
      </Structure>
    </Content>
  </StructuredXmlDocument>
  <Part>
    <ContentType>image/tif</ContentType>
    <Filename>page001.tif</Filename>
    <Content>
      <Binary>
        <!-- base64-encoded content of page001.tif -->
      </Binary>
    </Content>
  </Part>
</Import>
```

The first part contains a batch XML element according to ACEIDEF.dtd. The second part contains an image which is linked via name "page001.tif".

XML Mapping

In this chapter we are using the sample files installed along with KC Plug-In to clarify the use of XML mapping. You can find the sample files in the Samples\DemoMapping directory of the installation ISO.

Consider the traditional Kofax order example of a company "Northwest Products". This company has been receiving order forms from their customers per fax for years. Now, however, they decided to save costs and intend to allow their customers to send structured XML order data instead of faxes.

In this chapter we provide examples how to achieve this goal by the means of simple and generic XML mapping. For the sake of simplicity, we chose only a subset of order data:

The selected order data are to be mapped to the batch fields / index fields in the following way:

Input data fields	Map to		
	Batch fields	Document tables	Document index fields
Purchase Order No.	PONumber		
Ship To First Name		ShipTo	FirstName
Ship To Last Name			LastName
Quantity		Articles	Quantity
Item #			ItemNr
Description			Description
Unit Price			UnitPrice
Amount			Amount
Subtotal			Subtotal
Sales Tax			SalesTax
Shipping			Shipping
Total			Total

You can look at the KfxSampleXmlMappingBatch (also included in the samples folder) to see how these fields are defined in a batch class.

This is the desired outcome:

The screenshot shows the Kofax Capture Validation interface. On the left, there is a form with the following data:

- Ship To:
 - FirstName: Martin
 - LastName: Janeway
- Articles:
 - Quantity: 1
 - ItemNr: 638
 - Description: LANG STERLING PIE SERVER
 - UnitPrice: 32.95
 - Amount: 32.95
- Subtotal: 32.95
- Sales Tax: 2.55
- Shipping: 5
- Total: 40.5

On the right, the XML output is displayed:

```
<?xml version="1.0" encoding="UTF-8" ?>
- <OrdersGeneric
  xmlns:xsi="http://www.w3.org/2001/XMLSchema-instance"
  xsi:noNamespaceSchemaLocation="OrderGeneric.xsd">
- <Order PONumber="42367"
  BatchClassName="KfxSampleXmlMappingBatch"
  FormTypeName="KfxSampleXmlMappingForm">
- <ShipTo>
  <FirstName>Martin</FirstName>
  <LastName>Janeway</LastName>
</ShipTo>
- <Articles>
- <Article>
  <Quantity>1</Quantity>
  <ItemNr>638</ItemNr>
  <Description>LANG STERLING PIE
  SERVER</Description>
  <UnitPrice>32.95</UnitPrice>
  <Amount>32.95</Amount>
</Article>
</Articles>
<Subtotal>32.95</Subtotal>
<SalesTax>2.55</SalesTax>
<Shipping>5.00</Shipping>
<Total>40.50</Total>
</Order>
</OrdersGeneric>
```

The following procedures provide an overview of configuration tasks needed to set up the mapping. Refer to configuration section of *Kofax Import Connector Administrators Guide* for a more detailed description of configuration steps.

Using Sample Files

There are four examples in the mapping subdirectories of Samples\DemoMapping directory named AutoXmlMapping, GenericMapping, SimpleMapping and SimpleMappingManual; and a matching Kofax Capture batch class in the file KfxSampleXmlMappingbatch.cab.

To install these samples on your test environment:

- 1 Import the KfxSampleXmlMappingBatch.cab class to your Kofax Capture and publish it.
- 2 Add the corresponding XML type to the KC Plug-In (XML type is comprised by the xsd schema and xml sample files in the corresponding mapping subdirectory - except for XML Import Connector compatible example, where the build-in XML type is being used).
- 3 Add a destination to KC Plug-In where the mapping should occur. Configure it correspondingly (don't forget to set it batch class to "KfxSampleXmlMappingBatch") and click "Show Files for Visual Designer" in the ImportMapping Tab. Copy all files from the Samples\DemoMapping\<MappingType>XmlMapping\Sample<MappingType> to this directory (except for XML Import Connector compatible example, where the build-in XSL transformation is used).
- 4 As the simple input data you can use the provided sample XML file and the page002.tif file from the corresponding mapping subdirectory, but of course you can write your own "real" customer input XML data file (the provided trigger file can be used in the case of folder input driven by the trigger file).

Importing Structured Data via Simple XML Mapping

Northwest Products may select to use simple XML mapping. Their XML data could look like this:

```
<?xml version="1.0" encoding="UTF-8"?>
<Orders xmlns:xsi="http://www.w3.org/2001/XMLSchema-instance"
xsi:namespaceSchemaLocation="Order.xsd">
  <Order PONumber="42367">
    <ShipTo>
      <FirstName>Martin</FirstName>
      <LastName>Janeway</LastName>
    </ShipTo>
    <Articles>
      <Article>
        <Quantity>1</Quantity>
        <ItemNr>638</ItemNr>
        <Description>LANG STERLING PIE SERVER</Description>
        <UnitPrice>32.95</UnitPrice>
        <Amount>32.95</Amount>
      </Article>
    </Articles>
    <Subtotal>32.95</Subtotal>
    <SalesTax>2.55</SalesTax>
    <Shipping>5.00</Shipping>
    <Total>40.50</Total>
  </Order>
```

```
</Orders>
```

The schema file could look like this:

```
<?xml version="1.0" encoding="UTF-8"?>
<xs:schema xmlns:xs="http://www.w3.org/2001/XMLSchema">
  <xs:element name="Orders">
    <xs:complexType>
      <xs:sequence>
        <xs:element name="Order">
          <xs:complexType>
            <xs:sequence>
              <xs:element name="ShipTo">
                <xs:complexType>
                  <xs:sequence>
                    <xs:element name="FirstName" type="xs:string"/>
                    <xs:element name="LastName" type="xs:string"/>
                  </xs:sequence>
                </xs:complexType>
              </xs:element>
              <xs:element name="Articles">
                <xs:complexType>
                  <xs:sequence>
                    <xs:element name="Article">
                      <xs:complexType>
                        <xs:sequence>
                          <xs:element name="Quantity" type="xs:integer"/>
                          <xs:element name="ItemNr" type="xs:unsignedInt"/>
                          <xs:element name="Description" type="xs:string"/>
                          <xs:element name="UnitPrice" type="xs:decimal"/>
                          <xs:element name="Amount" type="xs:decimal"/>
                        </xs:sequence>
                      </xs:complexType>
                    </xs:element>
                  </xs:sequence>
                </xs:complexType>
              </xs:element>
              <xs:element name="Subtotal" type="xs:decimal"/>
              <xs:element name="SalesTax" type="xs:decimal"/>
              <xs:element name="Shipping" type="xs:decimal"/>
              <xs:element name="Total" type="xs:decimal"/>
            </xs:sequence>
            <xs:attribute name="PONumber" type="xs:int" use="required"/>
          </xs:complexType>
        </xs:element>
      </xs:sequence>
    </xs:complexType>
  </xs:element>
</xs:schema>
```

- 1 Add a new XML type "Orders" using the XML file and the schema file.
- 2 Add a new destination, assign it to the batch class KfxSampleXmlmappingBatch, document class KfxSampleXmlMappingDocument and form type KfxSampleXmlMappingForm. Do not forget to add a proper routing rule.
- 3 Select "Orders" as the XML type of the destination and select simple XML mapping.
- 4 Select to import original content (to Kofax Capture) but deactivate any conversions to TIF or PDF.
- 5 Create the desired mapping via MapForce, save it, and restart KC Plug-In.

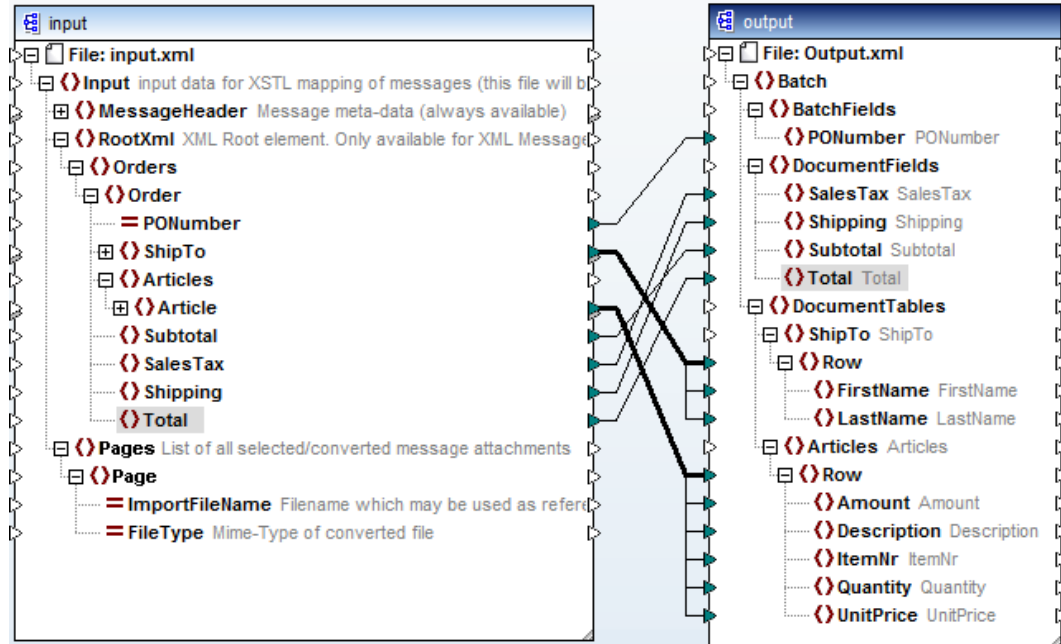

Alternatively, if you do not have MapForce, you can use the sample files from Samples \DemoMapping\SimpleMapping\SampleSimpleMapping. Click **Show files for Visual Designer** and copy all sample files to this folder.

The customers of Northwest Products can now send their orders in XML format via email or file interface. The structure of the XML must match the defined type Orders. Optionally, they can attach a TIF image of the order. The Kofax Capture batch fields are populated automatically, the XML file and the (optional) TIFF image are imported as the document's pages.

Note With simple mapping:

- All attachments received along with the XML files are automatically imported to Kofax Capture to the same batch/document class as pages, without being mentioned in the XSL transformation.
- If the fields in the batch class where XML data elements are being mapped to have the same names as the XML data elements, the mapping is easier.

Importing Structured Data via XML Import Connector-Compatible Mapping

For some reasons Northwest Products may have decided to model their input data using the standard Kofax Capture XML Import Connector format. In order to do so, the XML input data would look like this:

```
<?xml version="1.0" encoding="UTF-8"?>
<ImportSession xmlns:xsi="http://www.w3.org/2001/XMLSchema-instance">
  <Batches>
    <Batch BatchClassName="KfxSampleXmlMappingBatch">
      <BatchFields>
        <BatchField Value="42367" Name="PONumber"/>
      </BatchFields>
    </Batch>
  </Batches>
</ImportSession>
```

```

<Document FormTypeName="KfxSampleXmlMappingForm">
  <IndexFields>
    <IndexField Value="32.95" Name="Subtotal" />
    <IndexField Value="2.55" Name="SalesTax" />
    <IndexField Value="5.00" Name="Shipping" />
    <IndexField Value="40.50" Name="Total" />
  </IndexFields>
  <Tables>
    <Table Name="Articles">
      <TableRows>
        <TableRow>
          <IndexFields>
            <IndexField Value="1" Name="Quantity" />
            <IndexField Value="638" Name="ItemNr" />
            <IndexField Value="LANG STERLING PIE SERVER"
Name="Description" />
            <IndexField Value="32.95" Name="UnitPrice" />
            <IndexField Value="32.95" Name="Amount" />
          </IndexFields>
        </TableRow>
      </TableRows>
    </Table>
    <Table Name="ShipTo">
      <TableRows>
        <TableRow>
          <IndexFields>
            <IndexField Value="Martin" Name="FirstName" />
            <IndexField Value="Janeway" Name="LastName" />
          </IndexFields>
        </TableRow>
      </TableRows>
    </Table>
  </Tables>
  <Pages>
    <Page ImportFileName="page002.tif" />
  </Pages>
</Document>
</Documents>
</Batch>
</Batches>
</ImportSession>

```

As this is the standard Kofax format, the customer does not need to provide the XML schema file.

- 1 Add a new destination, assign it to the batch class `KfxSampleXmlmappingBatch`, document class `KfxSampleXmlMappingDocument` and form type `KfxSampleXmlMappingForm`. This information is only a fallback for the case that batch class information in the XML is not correct. Do not forget to add a proper routing rule.
- 2 Select "ImportSession" as the XML type of the destination and select XML Import Connector compatible mapping.
- 3 Select to import original but deactivate any conversions to TIF or PDF.
- 4 Restart KC Plug-In.

When using this standard Kofax format, MapForce is not needed.

In this scenario, attachments received along with the XML file are only imported to Kofax Capture if they are linked in the XML file (e.g. `<Page ImportFileName="page002.tif"/>`). The controlling XML document is never imported.

Importing Structured Data via Generic Mapping

For some reasons Northwest Products may have decided to use their own XML data format. They don't want to convert it to the standard Kofax Capture XML Import Connector format. However, they don't want to be bound to the same batch class/document class names. Instead, they want to provide additional attributes in the incoming XML data to select a particular batch class and form type. This requires generic XML mapping.

To link other documents from the controlling XML, all need to be imported at the same time: e.g., in the case of folder import, use trigger files or subfolder processing.

These are their sample XML input document and XML schema:

```
<?xml version="1.0" encoding="UTF-8"?>
<OrdersGeneric xmlns:xsi="http://www.w3.org/2001/XMLSchema-instance"
  xsi:noNamespaceSchemaLocation="OrderGeneric.xsd">
  <Order PONumber="42367" BatchClassName="KfxSampleXmlMappingBatch"
    FormTypeName="KfxSampleXmlMappingForm">
    <ShipTo>
      <FirstName>Martin</FirstName>
      <LastName>Janeway</LastName>
    </ShipTo>
    <Articles>
      <Article>
        <Quantity>1</Quantity>
        <ItemNr>638</ItemNr>
        <Description>LANG STERLING PIE SERVER</Description>
        <UnitPrice>32.95</UnitPrice>
        <Amount>32.95</Amount>
      </Article>
    </Articles>
    <Subtotal>32.95</Subtotal>
    <SalesTax>2.55</SalesTax>
    <Shipping>5.00</Shipping>
    <Total>40.50</Total>
  </Order>
</OrdersGeneric>
```

```
<?xml version="1.0" encoding="UTF-8"?>
<xs:schema xmlns:xs="http://www.w3.org/2001/XMLSchema">
  <xs:element name="OrdersGeneric">
    <xs:complexType><xs:sequence>
      <xs:element name="Order" maxOccurs="unbounded">
        <xs:complexType><xs:sequence>
          <xs:element name="ShipTo">
            <xs:complexType><xs:sequence>
              <xs:element name="FirstName" type="xs:string"/>
              <xs:element name="LastName" type="xs:string"/>
            </xs:sequence></xs:complexType>
          </xs:element>
          <xs:element name="Articles">
            <xs:complexType><xs:sequence>
              <xs:element name="Article">
                <xs:complexType><xs:sequence>
                  <xs:element name="Quantity" type="xs:integer"/>
                  <xs:element name="ItemNr" type="xs:unsignedInt"/>
                  <xs:element name="Description" type="xs:string"/>
                  <xs:element name="UnitPrice" type="xs:decimal"/>
                  <xs:element name="Amount" type="xs:decimal"/>
                </xs:sequence></xs:complexType>
              </xs:element>
            </xs:sequence></xs:complexType>
          </xs:element>
          <xs:element name="Subtotal" type="xs:decimal"/>
          <xs:element name="SalesTax" type="xs:decimal"/>
          <xs:element name="Shipping" type="xs:decimal"/>
          <xs:element name="Total" type="xs:decimal"/>
        </xs:sequence></xs:complexType>
      </xs:element>
    </xs:sequence></xs:complexType>
  </xs:element>
</xs:schema>
```

```

        <xs:element name="SalesTax" type="xs:decimal"/>
        <xs:element name="Shipping" type="xs:decimal"/>
        <xs:element name="Total" type="xs:decimal"/>
    </xs:sequence>
    <xs:attribute name="PONumber" type="xs:int" use="required"/>
    <xs:attribute name="BatchClassName" type="xs:string"/>
    <xs:attribute name="FormTypeName" type="xs:string"/>
</xs:complexType>
</xs:element>
</xs:sequence></xs:complexType>
</xs:element>
</xs:schema>

```

- 1 Add a new XML type "GenericOrders" using the XML file and the schema file.
- 2 Add a new destination. Assign it to any available batch class (this batch class will only be used if the batch class specified in the XML input is not available). Do not forget to add a proper routing rule.
- 3 Select "GenericOrders" as the XML type of the destination and select generic XML mapping.
- 4 Select to import original content (to Kofax Capture) but deactivate any conversions to TIF or PDF.
- 5 Create the desired mapping via MapForce and save it. Restart KC Plug-In afterwards. Alternatively, if you do not have MapForce, you can use the sample files from Samples \DemoMapping\GenericMapping\SampleGenericMapping. Click **Show files for Visual Designer** and copy all sample files to this folder.

These are the usual steps in generic mapping:

- a Map XML elements or attributes in the input.xml carrying class names directly to the corresponding attributes in the output.xml (see 1 in the screen shot below).
- b Required source elements or attributes in the input.xml document must be mapped to the corresponding name/value attribute pair in the output.xml document. The element's/attribute's name would control the name, and its value the value attribute in the corresponding position in the output.xml (see 2 in the screen shot below). This can be accomplished via MapForce's function block name(). If there are several element/attribute pairs to be mapped as separate index fields on the same output hierarchy (e.g. in the same document), it is necessary to duplicate the IndexField element in the output.xml to get more instances of the IndexField and map other source elements there. E.g., see how source elements "Subtotal" and "SalesTax" have been mapped in the step 2 below)
- c All received attachments and even the XML file itself are listed in the Pages sequence in the input.xml. If they also should be imported to Kofax Capture, the corresponding "ImportFileName" attribute must be explicitly mapped to the "ImportFileName" (and optionally to "OriginalFileName") attribute of the desired Page in the output.xml. See 3 in the screen shot.

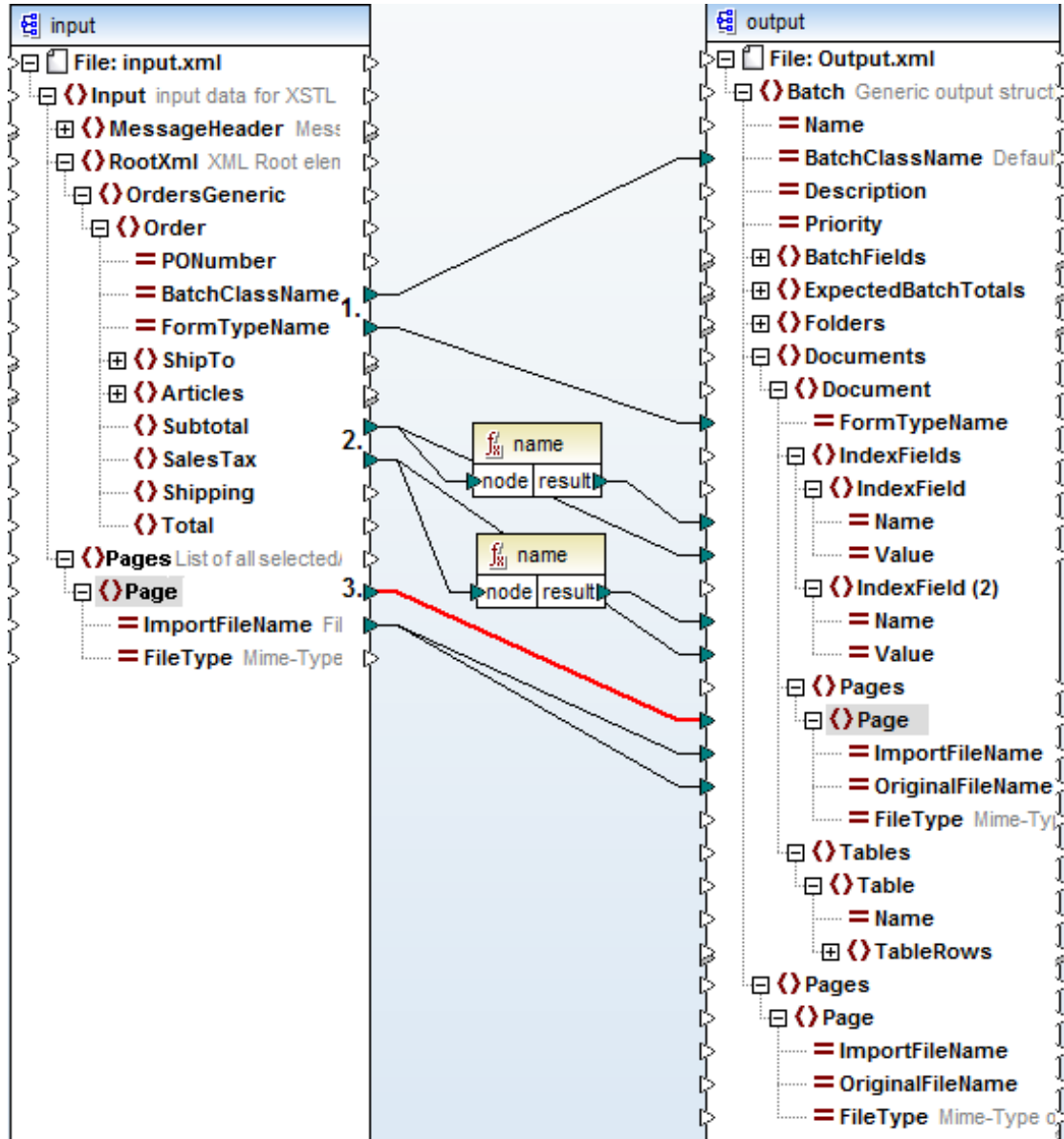

During the generation of the mapping in MapForce, it is possible to see how the sample XML document (of the destination's XML type) would be mapped using the current mapping. In our case it would look like this:

```
<?xml version="1.0" encoding="UTF-8"?>
<Batch xmlns:xsi="http://www.w3.org/2001/XMLSchema-instance"
  xsi:noNamespaceSchemaLocation="C:/ProgramData/Kofax/KCIC-E~1/
KCPLUG~1/config/Schemas/SampleGenericDestination2/output.xsd"
  BatchClassName="KfxSampleXmlMappingBatch">
  <Documents>
    <Document FormTypeName="KfxSampleXmlMappingForm">
      <IndexFields>
        <IndexField Name="Subtotal" Value="32.95"/>
        <IndexField Name="SalesTax" Value="2.55"/>
      </IndexFields>
      <Pages>
        <Page ImportFileName="filename.ext" OriginalFileName="filename.ext"/>
      </Pages>
    </Document>
  </Documents>
  <Table>
    <TableRows>
      <TableRow>
        <TableRowField Name="ImportFileName" Value="filename.ext"/>
        <TableRowField Name="OriginalFileName" Value="filename.ext"/>
        <TableRowField Name="FileType" Value="Mime-Type of file"/>
      </TableRow>
    </TableRows>
  </Table>
</Batch>
```

```

</Document>
</Documents>
</Batch>

```

Once all desired mappings are done, the final mapping would look like this:

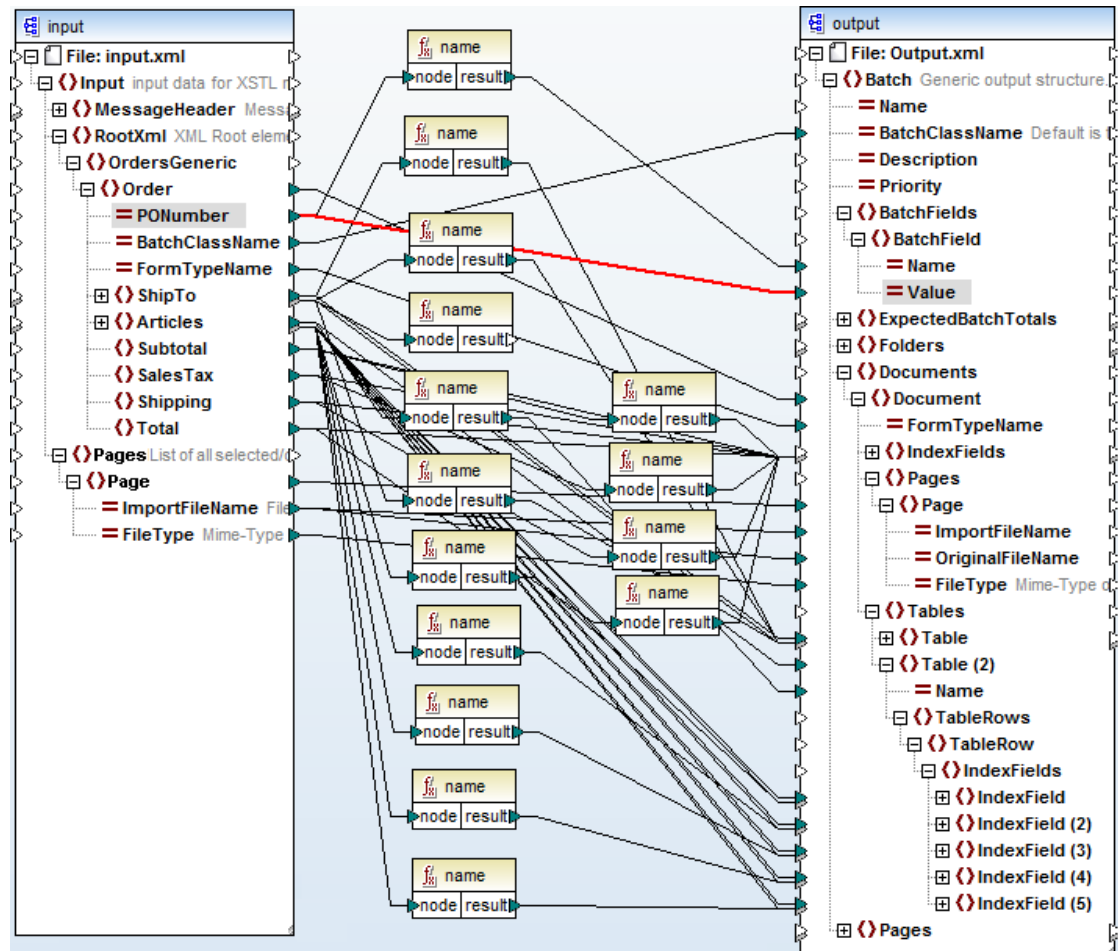

Creating XSL Transformations Manually

Northwest Products can decide to model their data exactly in the same way as explained in the first simple mapping example, but they don't want to use the third party tool MapForce and asked their XSLT expert to create the XSLT file for them manually.

Proceed exactly in the same way as in the first example, and once your destination with simple XML mapping has been created, click **Show Files for Visual Designer**. The following files are created:

File Name	Purpose
Input.Xml	<p>This is the sample input XML for the XSL transformation and consists of:</p> <ul style="list-style-type: none"> ▪ The message metadata in the MessageHeader element ▪ Customer's input XML itself (the Orders element) ▪ The list of all available attachments (the Files element) <p>A similar file is internally generated during operation of Kofax Import Connector for each received customer XML document (see screen shot below)</p>
Input.Xsd	This is the schema describing the input.xml structure. Both input XML and its schema files are always the same for both XML mapping variants – the simple and generic as well.
Output.Xml	This file defines the XML root element for the XML output of the XSL transformation.
Output.xsd	<p>This is the schema describing the structure of output.xml. There is a substantial difference between output.xsd generated for simple and generic mappings:</p> <ul style="list-style-type: none"> ▪ With simple mapping, output.xsd is generated according to batch / folder /document fields defined in the batch class assigned to the destination where the mapping occurs. Therefore, if anything changes in the batch class definition in Kofax Capture, a different schema file is generated. <p>Such a schema consists of four optional parts:</p> <ul style="list-style-type: none"> ▪ The sequence of all <i>BatchFields</i> (if any batch fields defined) ▪ The sequence of all <i>DocumentTables</i> (if any document tables defined) ▪ The sequence of all (non-table) <i>DocumentFields</i> (if any index fields defined) ▪ The sequence of all <i>ExpectedTotals</i> (if any total index fields defined) <ul style="list-style-type: none"> ▪ With generic mapping, output.xsd is always the same as it is not related to any specific batch class.

The Input.Xml could look e.g. like this:

```
<?xml version="1.0" encoding="utf-8"?>
<Input xsi:noNamespaceSchemaLocation="Input.xsd" xmlns:xsi="http://
www.w3.org/2001/XMLSchema-instance">
  <MessageHeader>
    <KfxMessageCorrelation>1</KfxMessageCorrelation>
    <KfxMessageDeliveryPriority>0</KfxMessageDeliveryPriority>
    <KfxMessageDeliverySuspectedDupli>>false</
KfxMessageDeliverySuspectedDupli>
    <KfxMessageDeliveryType>TO</KfxMessageDeliveryType>
    <KfxMessageID>message_id_sample</KfxMessageID>
    <KfxMessagePages>1</KfxMessagePages>
    <KfxMessageReceptionTimeCreated>2001-12-17T09:30:47Z</
KfxMessageReceptionTimeCreated>
    <KfxMessageSubject>message subject sample</KfxMessageSubject>
    <KfxOriginatorName>originator name sample</KfxOriginatorName>
    <KfxOriginatorNumber>originator@localhost</KfxOriginatorNumber>
```

```

    <KfxOriginatorService>EMAIL</KfxOriginatorService>
    <KfxRecipientName>Orders sample</KfxRecipientName>
    <KfxRecipientNumber>orders@localhost</KfxRecipientNumber>
    <KfxRecipientService>EMAIL</KfxRecipientService>
  </MessageHeader>
  <RootXml>
    <Orders xmlns:xsi="http://www.w3.org/2001/XMLSchema-instance">
      <Order PONumber="42367">
        <ShipTo>
          <FirstName>Martin</FirstName> <LastName>Janeway</LastName>
        </ShipTo>
        <Articles>
          <Article>
            <Quantity>1</Quantity> <ItemNr>638</ItemNr>
            <Description>LANG STERLING PIE SERVER</Description>
            <UnitPrice>32.95</UnitPrice> <Amount>32.95</Amount>
          </Article>
        </Articles>
        <Subtotal>32.95</Subtotal>
        <SalesTax>2.55</SalesTax>
        <Shipping>5.00</Shipping>
        <Total>40.50</Total>
      </Order>
    </Orders>
  </RootXml>
  <Files>
    <File ImportFileName="filename.ext" />
  </Files>
</Input>

```

The XSL transformation in Kofax Import Connector involves the following actions:

- 1 Input.Xml structure is generated for each received message.
- 2 The XSL transformation is executed and its output is an internal representation of Output.Xml.
- 3 Output.Xml is parsed and corresponding batch fields are created/filled with the input data.

If you want to create XSL transformations manually, proceed as follows:

- 1 Consider your input.xml data (along with the schema file).
- 2 Consider the output data definition in output.xsd.
- 3 Create a XSL transformation that converts the input.xml like data to output.xml.
- 4 Save the created XSLT file as "XMLMapping.xslt" to the destination's visual designer folder. You can click **Show Files for Visual Designer** in the destination settings to open the folder.

If you don't want to create the file manually, you can use the sample file from the folder Samples\DemoMapping\SimpleMappingManual\SampleSimpleMappingManual.

An XSL transformation that fulfills the same task as in the simple XML mapping example could look like this:

```

<?xml version="1.0" encoding="UTF-8"?>
<xsl:stylesheet version="1.0" xmlns:xsl="http://www.w3.org/1999/XSL/
Transform" xmlns:xs="http://www.w3.org/2001/XMLSchema"
xmlns:fn="http://www.w3.org/2005/xpath-functions">
  <xsl:output method="xml" version="1.0" encoding="UTF-8" indent="yes"/>
  <xsl:template match="/">
    <Batch><xsl:apply-templates/></Batch>
  </xsl:template>
  <xsl:template match="MessageHeader"/>
  <!--Ignore MessageHeader-->

```

```

<xsl:template match="Files"/>
<!--Ignore Files-->
<xsl:template match="RootXml/Orders/Order">
  <BatchFields>
    <PONumber><xsl:value-of select="@PONumber"/></PONumber>
  </BatchFields>
  <DocumentTables>
    <xsl:apply-templates select="ShipTo|Articles"/>
  </DocumentTables>
  <DocumentFields>
    <Subtotal><xsl:value-of select="Subtotal"/></Subtotal>
    <SalesTax><xsl:value-of select="SalesTax"/></SalesTax>
    <Shipping><xsl:value-of select="Shipping"/></Shipping>
    <Total><xsl:value-of select="Total"/></Total>
  </DocumentFields>
</xsl:template>
<xsl:template match="ShipTo">
  <ShipTo>
    <Row>
      <FirstName><xsl:value-of select="FirstName"/></FirstName>
      <LastName><xsl:value-of select="LastName"/></LastName>
    </Row>
  </ShipTo>
</xsl:template>
<xsl:template match="Articles">
  <Articles>
    <xsl:for-each select="Article">
      <Row>
        <Quantity><xsl:value-of select="Quantity"/></Quantity>
        <ItemNr><xsl:value-of select="ItemNr"/></ItemNr>
        <Amount><xsl:value-of select="Amount"/></Amount>
        <Description><xsl:value-of select="Description"/></Description>
        <UnitPrice><xsl:value-of select="UnitPrice"/></UnitPrice>
      </Row>
    </xsl:for-each>
  </Articles>
</xsl:template>
</xsl:stylesheet>

```

Web Services Sample Client

Kofax Import Connector includes two sample client applications for web service input. You can find them in CSharpClient.zip file on the installation ISO, in the Samples\WebService folder.

- Import.exe is a command line tool for importing documents to Message Connector.
- EDocGui.exe is a more advanced application with a graphical user interface.

For detailed information about the prerequisites, configuration, and operation of the sample clients, please refer to readme.txt (in the Export folder of CSharpClient.zip).

The source code of the applications are also included in the zip file, in the EDocGui and EDocImport folders. The sample programs are written .NET CSharp.

Web Services Interface for Kofax Monitor

KC Plug-In and Message Connector offer web service interface functions for use with Kofax Monitor.

KC Plug-In

GetAllStates Function

This function returns the status of Kofax Import Connector feature licenses and the status of all connections.

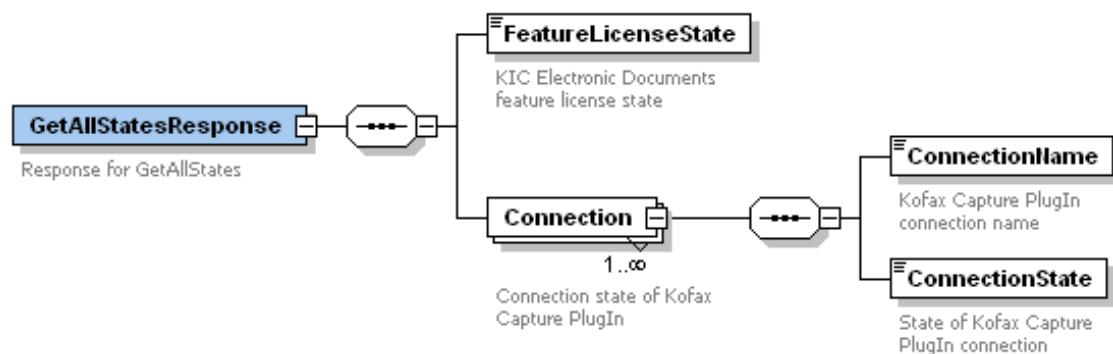

The FeatureLicenseState values are defined in the table below:

Value	Description
0	License OK
1	License invalid.
65536	Evaluation license found.

The ConnectionState values are defined in the table below:

Value	Description
-1	Connection is active but not connected.
0	Connection is inactive.
1	Connection is active and connected.

Example:

```
<s:Body xmlns:xsi="http://www.w3.org/2001/XMLSchema-instance"
  xmlns:xsd="http://www.w3.org/2001/XMLSchema">
  <GetAllStatesResponse xmlns="http://www.kofax.com/2011/KIC-
  ElectronicDocuments">
    <FeatureLicenseState>1</FeatureLicenseState>
    <Connection>
      <ConnectionName>Connection2</ConnectionName>
      <ConnectionState>1</ConnectionState>
    </Connection>
    <Connection>
      <ConnectionName>Connection3</ConnectionName>
      <ConnectionState>0</ConnectionState>
    </Connection>
  </GetAllStatesResponse>
</s:Body>
```

GetConnection Function

This function returns the status of a connection between KC Plug-In and Message Connector.

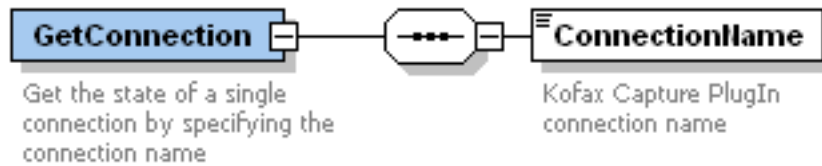

On success, the function returns the status of the specified connection.

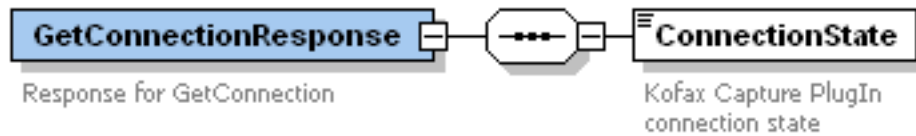

The ConnectionState values are defined in the table below:

Value	Description
-1	Connection is active but not connected.
0	Connection is inactive.
1	Connection is active and connected.

Example:

```
<s:Body xmlns:xsi="http://www.w3.org/2001/XMLSchema-instance"
  xmlns:xsd="http://www.w3.org/2001/XMLSchema">
  <GetConnectionResponse xmlns="http://www.kofax.com/2011/KIC-
  ElectronicDocuments">
    <ConnectionState>-1</ConnectionState>
  </GetConnectionResponse>
</s:Body>
```

GetConnectionNames Function

This function returns the names of all connections between KC Plug-In and Message Connector.

On success, the function returns a GetConnectionNamesResponse containing the names of all connections.

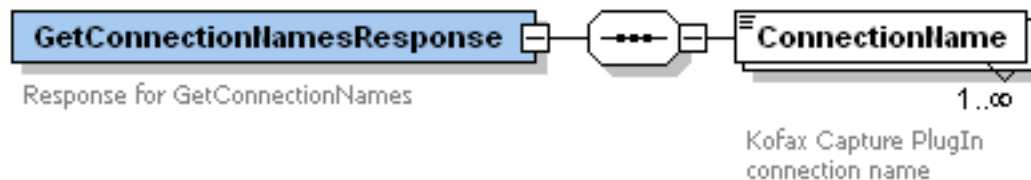

Example:

```
<s:Body xmlns:xsi="http://www.w3.org/2001/XMLSchema-instance"
  xmlns:xsd="http://www.w3.org/2001/XMLSchema">
  <GetConnectionNamesResponse xmlns="http://www.kofax.com/2011/KIC-
  ElectronicDocuments">
    <ConnectionName>Connection2</ConnectionName>
    <ConnectionName>Connection3</ConnectionName>
  </GetConnectionNamesResponse>
</s:Body>
```

GetFeatureLicenseState Function

This function returns the status of Kofax Import Connector feature licenses.

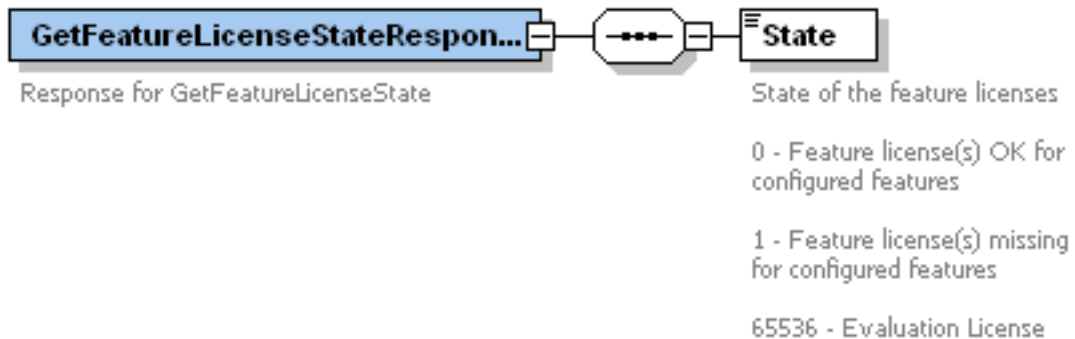

Example:

```
<s:Body xmlns:xsi="http://www.w3.org/2001/XMLSchema-instance"
  xmlns:xsd="http://www.w3.org/2001/XMLSchema">
  <GetFeatureLicenseStateResponse xmlns="http://www.kofax.com/2011/KIC-
  ElectronicDocuments">
    <State>1</State>
  </GetFeatureLicenseStateResponse>
</s:Body>
```

Message Connector

GetRunState Function

This function is used in conjunction with Kofax Monitor. It returns the run state of Message Connector. The function has no parameters and returns a response as shown below:

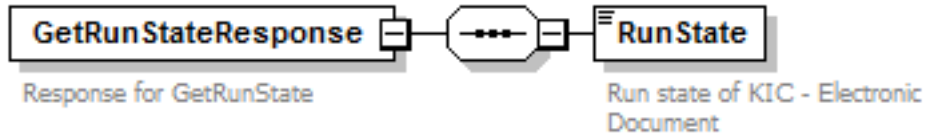

The RunState values are defined in the table below:

Value	Description
0	Not running
80	Storage full, no documents accepted into storage; import to Kofax Capture continues
100	Running

GetStorageVisible Function

This function is used in conjunction with Kofax Monitor. It returns how full is the storage of Message Connector, in percent.

The GetStorageVisible function has no parameters and returns a response as shown below:

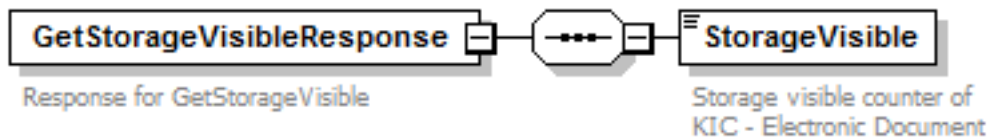

GetMessagesFailed Function

This function is used in conjunction with Kofax Monitor. It returns number of messages that could not be imported to Kofax Capture and need to be processed.

The GetMessagesFailed function has no parameters and returns a response as shown below:

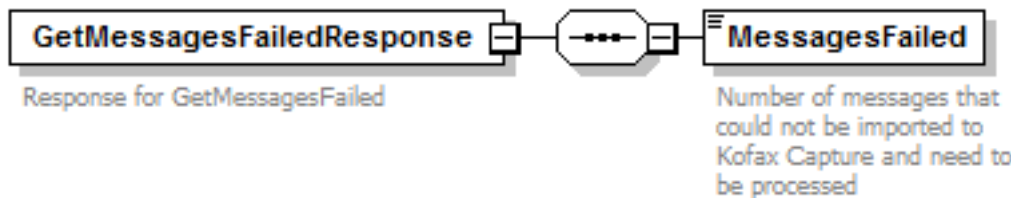

Scripting Interface

The KC Plug-In module contains a custom scripting interface that allows customizing how messages are imported into Kofax Capture. This is done via C# scripts. When configured, scripts run just before the content is imported into Kofax Capture and can modify or add field values or alter the binary content of the files, discard or add new binary content, or do any other alteration to the message fields or content. Additionally, scripts can e.g. make a call to a database to validate or look up data and then add looked up values to document or batch fields, or if desired abort message import and inform the Message Connector that a message has been rejected.

The KC Plug-In module can use

- scripts to create specific batch names
- custom document scripts to perform specific actions on the message fields or content before the message is imported into Kofax Capture.

In addition to the KC Plug-In, a scripting DLL and a sample Visual Studio 2008 project are provided. These enable you to create, run, and test your scripts in Visual Studio before you deploy them to the KC Plug-In. Please note that the provided DLL is only for making debugging easier, neither the DLL nor Visual Studio are required to create scripts. Scripts do not have to be compiled before deployment. You can also create scripts in any text editor.

The sample project is located in:

- <programs>\Kofax\KIC-ED\KCPlugIn\ScriptSample\KCSImportScriptingSample.zip

The scripts, though written in C#, do not need to be compiled. You just have to configure the path to your script source file in the KC Plug-In configuration. When the plug-in starts, it will build the script on the fly and run it before your messages are imported or to get a batch name just before the batch is created.

The batch naming script has to implement a special *IBatchNameFormatter* interface. If an error occurs in the script, the connector writes the error to a log file and the default batch naming configured in the batch class is used. If the script is not configured the default batch name configured in the Kofax Capture batch class is used.

The custom document script has to implement a special *IDocumentScript2* interface. It runs just before a message is imported into Kofax Capture. In the script, you can make any desired changes to the document content.

Adding References to Scripts

To add a reference to an assembly that is already in path, add a line beginning with `//GAC:` followed by the DLL names delimited by comma as a first line to your script.

```
//GAC:System.Data.dll
```

To add references to any other assemblies, add a line beginning with `//ref:` followed by the full paths to your DLLs delimited by comma as a second line to your script.

```
//ref:c:\temp\myref1.dll,c:\temp 2\myref2.dll, c:\temp 3\myref3.dll
```

IBatchNameFormatter Interface Definition

This is the definition of the `IBatchNameFormatter` interface

```
using System;
using System.Collections.Generic;
using System.Text;
using Kofax.KCS.ImportConnector.Messages;

namespace Kofax.KCS.ImportConnector.Scripting
{
    public interface IBatchNameFormatter
    {
        string GetBatchName(ReadOnlyMessage[] msg);
    }
}
```

The `ReadOnlyMessage[]` array contains all the messages that are part of a batch. If it is a single message batch, then the array contains only 1 message at position 0. All the properties and fields values are read-only. You cannot change any of those values using this interface. You can use any of the defined Kofax Capture variables, e.g. "{Sequence Number}". Kofax Capture variables are translated to Kofax Capture values. (Please refer to the Kofax Capture documentation for more information about Kofax Capture variables).

The returning string from the function is the actual batch name.

Note If you write custom batch naming scripts you should pay attention that the batch names must be unique, otherwise the batch creation in Kofax Capture will fail.

Table 5-1. ReadOnlyMessage properties

Property Name	Type	Description
Fields	IDictionary <string, string>	<p>The collection of Key-Value - pairs containing field names in the key values and the field values in the value values.</p> <p>The collection contains the standard message fields listed below and any extension fields if they are defined in Message Connector.</p> <p>(Message fields are information that Message Connector delivers with each message.</p> <p>Message extension fields are currently not provided by Message Connector and should not be used. They are reserved for future use.)</p> <p>Standard message fields are described in the Administrator's Guide</p>
DestConfig	Object (Destination Config)	The configuration of the destination to which the message has been redirected. Do NOT modify the properties of this object!

IDocumentScript2 Interface Definition

This is the definition of the IDocumentScript2 interface

```
public interface IDocumentScript2
{
    /// <summary>
    /// Called before the import content and import order is determined
    /// Body and attachment content and import order can be manipulated in this
    /// function
    /// </summary>
    /// <param name="messageBody">A read-only instance of the message being
    /// imported</param>
    /// <param name="messageBody">The list of the received message bodies.</
    param>
    /// <param name="attachments">The list of the received attachments.</param>
    /// <param name="extension">Reserved for future use.</param>
    void ManageMessageFiles(ReadOnlyMessage message,
        List<Attachment> messageBody,
        List<Attachment> attachments,
        object extension);
    /// <summary>
    /// Called before a document is imported into KC
    /// </summary>
    /// <param name="indexFields">The list of index fields defined in the
    /// configured document class.
    /// If document class not defined this will be empty.</param>
    /// <param name="folderFields">The list of folder fields defined in the
    /// configured folder class.
    /// If folder class not defined this will be empty.</param>
    /// <param name="batchFields">The list of batch fields defined in the
    /// configured batch class.</param>
    /// <param name="messageBody">The list of the received message bodies.</
    param>
    /// <param name="attachments">The list of the received attachments.</param>
    /// <param name="extension">Reserved for future use.</param>
    void BeforeDocumentImport(IDictionary<string, string> indexFields,
        IDictionary<string, string> folderFields,
        IDictionary<string, string> batchFields,
        List<Attachment> messageBody,
        List<Attachment> attachments,
        object extension);

    /// <summary>
    /// Called before a message is imported into KC
    /// </summary>
    /// <param name="indexFields">The list of index fields defined in the
    /// configured document class.
    /// If document class not defined this will be empty.</param>
    /// <param name="folderFields">The list of folder fields defined in the
    /// configured folder class.
    /// If folder class not defined this will be empty.</param>
    /// <param name="batchFields">The list of batch fields defined in the
    /// configured batch class.</param>
    /// <param name="messageBody">The list of the received message bodies.</
    param>
    /// <param name="attachments">The list of the received attachments.</param>
    /// <param name="extension">Reserved for future use.</param>
    void BeforeMessageImport(IDictionary<string, string> indexFields,
        IDictionary<string, string> folderFields,
        IDictionary<string, string> batchFields,
        List<Attachment> messageBody,
        List<Attachment> attachments,
        object extension);
}
```

```
}

```

If defined, the `ManageMessageFiles` function implementation is run before the import content and import order is determined. Here you can manipulate the import content: add new content, discard content, and change existing content. You can discard binary content by setting a `DoImport` flag of the binary content to false to skip the import of that attachment or body.

If defined, the `BeforeDocumentImport` function implementation runs before each Kofax Capture document is created.

If defined, the `BeforeMessageImport` function implementation runs before each message is imported into Kofax Capture

The input parameters for the `BeforeDocumentImport` and `BeforeMessageImport` methods are the list of all folder, document and batch field values, the list of all message bodies, and the list of all attachments. Here you can manipulate batch, folder, and document field values. The list of bodies and attachments are only for reading in these functions. You cannot change the import content. If you need to manipulate the import content this should be done in `ManageMessageFiles`.

The `indexFields` parameter contains a key-value pair list containing all the index fields defined for the used document class. If a document class is not configured or if there are no index fields defined, this will be empty. The key property contains the index field name and the value property contains the index field value.

The `folderFields` parameter contains a key-value pair list containing all the folder fields defined for the used folder class. If a folder class is not configured or if there are no folder fields defined, this will be empty. The key property contains the folder field name and the value property contains the folder field value.

The `batchFields` parameter, similar to the `indexFields` and `folderFields` parameter contains a key-value pair list containing all the batch fields defined for the used batch class. If there are no batch fields defined, it is empty. The key property contains the batch field name and the value property contains the batch field value.

The `messageBody` parameter contains all selected representations of the message body (original, PDF, TIF).

The `attachments` parameter contains all selected representations of the attachments (original, PDF, TIF).

Table 5-2. Attachment class properties

Property Name	Type	Description
Extension	String	The extension of the received file
LongOrBinaryFileName	String	The file name of the received attachment/body. The connector first looks for the long file name, if it does not exist, then it takes the binary file name, which is the short file name.
HierarchicalPosition	String	MC hierarchical position of the file.
DoImport	Bool	By default it is true. If you set this value to false in your script, this attachment/body will not be imported into Kofax Capture

Property Name	Type	Description
Content	Byte[]	The binary content of a body/attachment. If it is text, then it is encoded using the default Windows encoding for on the computer where the connector runs.
DocConversionError	String	If there was a document conversion error for this document, this property will contain the description of the error
IsOriginal	Bool	Indicates if a file is an original file or a converted file
IsImage	Bool	Indicates if it is an image or another file format
IsOriginalEml	Bool	Indicates if it is the EML representation of the original message
ContentID	String	MIME content ID. If not set by Message Connector the value is null.
ContentDisposition	String	MIME content disposition. If not set by Message Connector the value is null.
CreationDate	DateTime	MIME creation date of original attachment. If not set by Message Connector the value is 01.01.0001 00:00:00.
ModificationDate	DateTime	MIME modification date of the original attachment. If not set by Message Connector the value is 01.01.0001 00:00:00.
ContentType	String	MIME type of the original attachment. If not set by Message Connector, the KC Plug-In will set it depending on the file extension of the attachment.
ActualType	String	Type of the attachment set by Message Connector. Possible values: TEXT , BINARY_IMAGE, BINARY_nonIMAGE, ROOT_XML.
IsXmlRendering	Bool	Indicates that the attachment is the result of a converted XML document.
OriginalFileName	String	Contains the original file name of the attachment with the original extension (e.g., when a document has been converted, it now has a different name/extension).

Rejecting Messages from Script

You can perform checks and reject messages with scripts that implement the `IDocumentScript2` interface. To reject a message, throw an exception of the type `ScriptException` with the desired description as an argument. The description is then displayed in Message Connector Monitor.

Ignoring Messages from Script

You can perform checks and ignore messages with scripts that implement the `IDocumentScript2` interface. To ignore a message, throw an exception of the type `ScriptIgnoreMessageException` with the desired description as an argument. In order to work correctly `ScriptIgnoreMessageException` needs to be thrown from the function `ManageMessageFiles`. Optionally, when throwing the exception you can also select not to send a notification and not to archive the message by passing false as value for `doNotifyArchive` in the exception constructor. Similar to reject, ignore causes the message not to be imported into Kofax Capture. The difference is however, that ignore will send a positive confirmation back to Message Connector and provides the option to turn off archiving and notifications for such messages.

Custom Conversion Script

The document conversion function in Message Connector knows many file types (extensions) and selects the appropriate document conversion tools and options automatically. The custom conversion script allows you to configure an additional list of file extensions that should be converted to PDF.

Configuring Custom Conversion Script

Message Connector must be configured to take advantage of the custom conversion script.

- 1 In the Message Connector Configuration, Document Conversion tab, in the Custom Extension List field, specify a blank separated list of file extensions (without dot) that your script is going to convert to PDF. Save the configuration and restart the Message Connector service.
- 2 Create a batch file as shown below that performs the conversion to PDF. Save is as “CustomToPdf.bat” to the Scripts subfolder of the Message Connector installation directory.
- 3 Test the conversion with the “Convert Document” test page of the Message Connector Web Portal

Sample Script

A simple template for the “CustomToPdf.bat” script is shown here; instead of converting to PDF the source file is only copied to the target.

```
@ECHO OFF
REM A simple custom conversion script example.
REM The source file is copied to the destination file.
REM A productive script has of course to create a PDF file from the source
file.
REM For examples see the files of the Scripts folder.
REM Parameters:
REM %1 SourceFile
REM %2 TargetFile
REM %3 Utf8TextFile (0 - Other, 1 - Utf8)

ECHO Called: Custom2pdf.bat %*
setlocal

REM Copying source file to destination file
copy %1 %2

ECHO Error level=%errorlevel%
```

You can find examples that actually perform a conversion in the Scripts folder.

Custom Storage Strings

When you configure a destination in KC Plug-In, you can map some of the document metadata to document and folder fields of a Kofax Capture batch class.

However, only a subset of document metadata is available for use with the user interface. All metadata is available in Kofax Capture as custom storage strings (for documents and folders).

Custom storage strings can be read via the Kofax Capture API and could be used for example in an export connector or in custom scripts.

Most custom storage strings are available for each document and for each folder. Refer to the Description column for exceptions.

Custom storage string	Description
ED_CSS_KfxOriginatorService	The service name of the originator. In case of fax FAX and in case of email EMAIL.
ED_CSS_KfxOriginatorNumber	The fax number of the originator (caller ID) or originator email (mime-header/from/mailbox/address) for POP3/SMTP mail.
ED_CSS_KfxOriginatorName	The full name of the message originator. For faxes, this is the TSI. For SMTP and POP3, it's the originator display name (mime-header/from/mailbox/displayname).
ED_CSS_KfxRecipientService	The service name of the recipient. In case of fax FAX and in case of email EMAIL.
ED_CSS_KfxRecipientNumber	The recipient fax number (called party number) or email address (for SMTP it's the first active email recipient, for POP3 the mailbox user name).
ED_CSS_KfxRecipientName	The full name of the message recipient. For POP3, this is the mailbox display name.
ED_CSS_KfxMessageCorrelation	The correlation information of the message (for internal use).
ED_CSS_KfxMessageID	The unique ID of the message given by the Message Connector on message arrival.
ED_CSS_KfxMessageSubject	The subject of the message. For faxes, this is "Fax from" + TSI.
ED_CSS_KfxMessageReceptionTimeCreated	MAIL: The time when the Message Connector retrieved the message. FAX: The time when the fax server received the message.
ED_CSS_KfxMessageReceptionCallerId	The number of the sending fax machine. (Optionally available for FoIP, Biscom, KCS)
ED_CSS_KfxMessagePages	The number of fax pages in the message.
ED_CSS_KfxMessageDeliveryType	The type of delivery of the message. Reserved for future use. Currently static string "TO".

Custom storage string	Description
ED_CSS_KfxMessageDeliveryPriority	The priority of the message. Reserved for future use. Currently static value "1".
ED_CSS_KfxMessageDeliverySuspectedDupli	Reserved for future use. Currently static value "0".
ED_CSS_KfxRoutingNumber	The meaning of this message field is different for various inputs <ul style="list-style-type: none"> ▪ FAX: Extension (called-party-number) ▪ SMTP: active email recipient ▪ POP3/IMAP: mailbox user name ▪ FOLDER: full path to the imported file ▪ WEBSERVICE: empty string
ED_CSS_KfxMessageTimePosted	Only available for email messages, this field contains the date and time when the message was sent.
ED_CSS_KfxRecipientsTo	Comma separated list of "To" recipients.
ED_CSS_KfxRecipientsCc	Comma separated list of "Cc" recipients.
ED_CSS_Batchname	The name of imported Kofax Capture batch.
ED_CSS_Batchclass	The batch class name of imported Kofax Capture batch.
ED_CSS_Import-Date-Short	The import date in the form YYYY-MM-DD.
ED_CSS_Import-Date-Long	The import date in the form YYYY-MM-DDTHH-MM-SS.
ED_CSS_Batch-Id	The batch ID of the imported Kofax Capture batch.
ED_CSS_VRS-Error	The VRS error description in the case of VRS error. (Document only)
ED_CSS_OriginalFileName, ED_CSS_OriginalFileNamePageNr	For documents, this string stores the full path of the original content file. This string is available when you enable "Include original content" in the destination configuration and "Originals import mode" is set to "Save to disk". For folder, this string stores the full path of the saved EML file. This string is available when you enable "Include complete message as EML file" in the destination configuration and "Originals import mode" is set to "Save to disk". PageNr is the page number of the first page of the related converted document in Kofax Capture. E.g.: <ul style="list-style-type: none"> ▪ ED_OriginalFilename1: C:\..\Images\0000CC4\200\ 1_original.tif ▪ ED_OriginalFilename3: C:\..\Images\0000CC4\200\ 3_original.tif
ED_CSS_DocPerAttachment	The document creation mode used for import (Document only): <ul style="list-style-type: none"> ▪ True: One document per each attachment ▪ False: One document per message